

# LAMPOLITE

Part number / Numéro de produit  
AB26-10-GN01-24

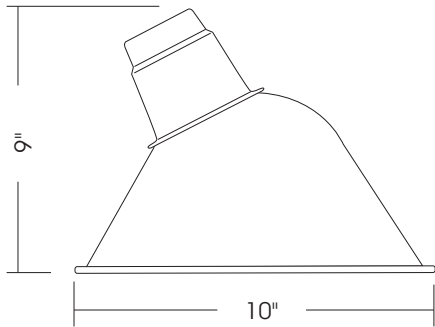

# Shade part number / Numéro de produit - réflecteur AB26-10

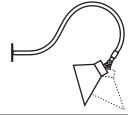

**OPTION:** Shades are also available with a swivel option for more precise lighting adjustments.  
Les réflecteurs sont aussi disponibles avec un pivot en option pour un ajustement plus précis de l'éclairage.

Swivel / Pivot  Ex.: 

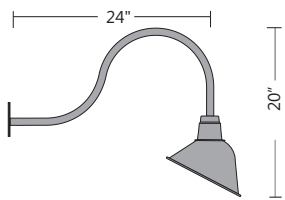

AB26-10-GN01-24

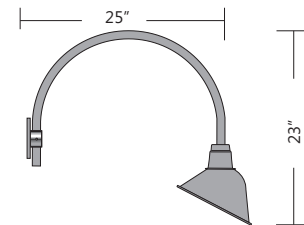

AB26-10-GN14-17

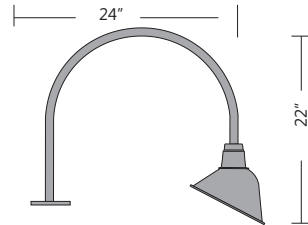

AB26-10-GN16-20

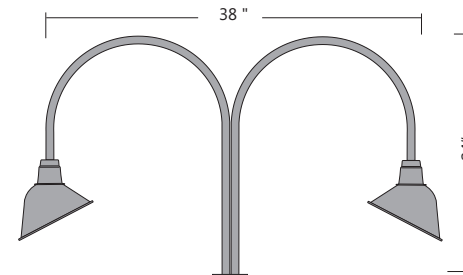

AB26-10-GN20

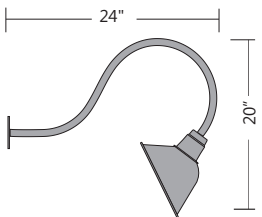

AB26-10-GN01-24C

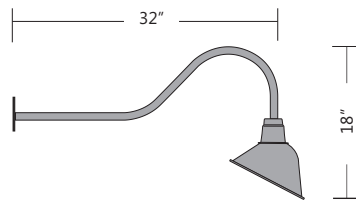

AB26-10-GN09-32

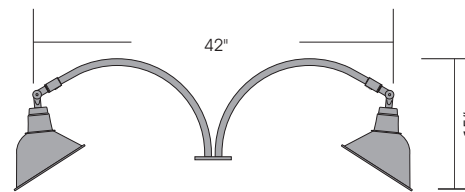

AB26-10-GN12-42

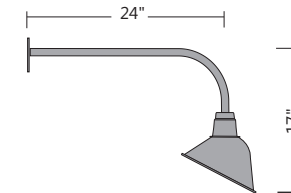

AB26-10-GN17-24

THE FINAL PRODUCT MAY VARY SLIGHTLY  
COMPARED TO THE APPROVED TECHNICAL DRAWING

ALL DRAWINGS REMAIN THE PROPERTY OF LAMPOLITE  
TOUS LES DESSINS TECHNIQUES DEMEURENT LA PROPRIÉTÉ DE LAMPOLITE

# FINISH / FINITION

---

The standard goose neck is available in satin white, satin black, silver cooked enamel paint or naturel finish (brushed aluminium) protected with a clear varnish. Upon request, the goose neck may be painted. The RAL, PANTONE, Sico, or Benjamin Moore color code must be provided.

---

Les cols de cygne standards sont peints à l'émail cuit, en blanc, noir, gris métallique, ou conservent une finition naturelle aluminium brossé, protégé d'un vernis clair. Sur demande, les cols de cygne peuvent être peint selon un code de couleur RAL, PANTONE, Sico, ou Benjamin Moore

SATIN BLACK / NOIR SATINÉ



BRUSHED ALUMINIUM / ALUMINIUM BROSSÉ



SATIN WHITE / BLANC SATINÉ



SILVER / GRIS MÉTALLIQUE



Ex.:



BRUSHED ALUMINIUM / ALUMINIUM BROSSÉ

Color code / Code de couleur

